

PT01109-3 Submersible Geiger-Muller Radiation Detector

The **PT01109-3** is a seawater submersible low power sensor, which integrates the temperature and depth gauges with Geiger-Muller detector. It has been designed for surveying ocean euphotic depth up to 150m for artificially produced radionuclides as well as Naturally Occurring Radioactive Materials (NORM).

The instrument can be used by industrial fisher to help them measure the seawater radioactive contamination on multiple depths before fishing attempt. The result of the measurement should help to optimize decision about selecting the fishing region and desisted fishing in case of contamination of the seawater. It also can be used on the buoy to monitor radionuclides level on sea waterways and roadsteads.

The instrument is sensitive to gamma radiation with energy levels from 50keV to 1.25MeV and measure low level radiation emission sources. Typically, the **PT01109-3** sensors are hanging on immersed vertical cable (each sensor in a different depths), and automatically perform readings of seawater temperature, radiation in counts per minute [cpm] and the sensor depth. Each sensor reading is transmitted to the surface base station located in vessel cockpit by wire connection.

Features:

- Low power sensors can be permanently immersed in seawater up to 150m depth
- Remote sensor reading of seawater gamma radiation, temperature and sensor depth
- Remote self-diagnostic function of the sensor
- Gamma radiation sensor is energy-compensated Geiger-Muller tube; sensitive: with an energy level from 50keV to 1.25MeV; gamma sensitivity: 22 cps/mR/h (Co^{60}); working range: 0.014 -144 mR/h
- Background compensated measurement of low level gamma radiation in counts per minute [cpm]
- Operating temperature range from -5°C to 60°C (all components industrial grade -40°C to 85°C)
- Sensors intrinsic safe powered from Surface Base Station
- Surface Base Station and immersed sensors are point-to-multipoint network
- Designed to operate within harsh industrial environments
- Surface Base Station capable to support SAT ARGOS PTT or GSM/GPRS modem

Applications:

- Survey of ocean euphotic depth up to 150m to measure radiation levels from NORM (Naturally Occurring Radioactive Materials) and artificially produced radionuclides such as I-131, Cs-134, Cs-137, Pu-239, Pu-240, Sr-90.
- Help to optimize decision about selecting the fishing region.
- For monitoring radionuclide levels on sea waterways, roadsteads and seaside facilities.

PT01109-3 Submersible Sensor

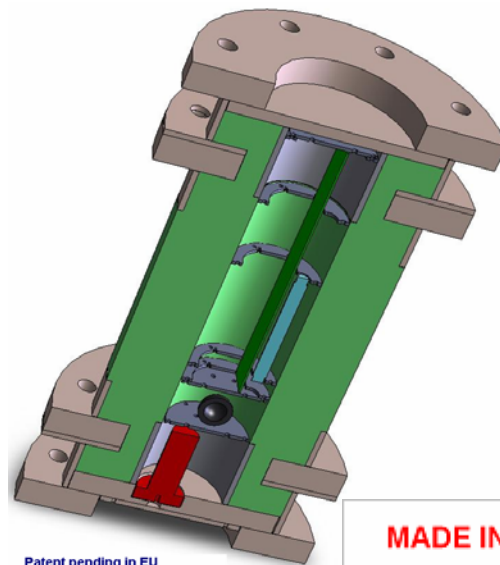

Patent pending in EU

MADE IN

POLAND

Designed to meet EC/ANSI Declaration of Conformity requirements:

- ANSI N42.35-2004 Evaluation and Performance Criteria of Radiation Detection Portal Monitor for Use in Homeland Security (excluding requirements 5.10 and 5.10.4.2)
- Polish Register of Shipping (PRS) 2007 -Rules for Classification and Construction of Sea-going Ship Part 8 -Electrical Installation and Control System
- EN 61000-6-2 Immunity standard for industrial environments
- EN 61000-6-4 Emission standard for industrial environments
- EN 60079-0 Electrical apparatus for explosive gas atmospheres. General requirements
- Ready for Maritime Safety approval

Block Diagram of PT01109-3 Submersible Geiger-Muller Radiation Detectors System

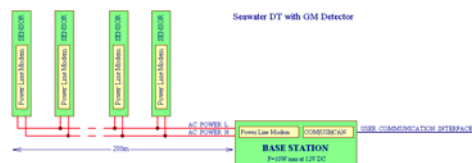
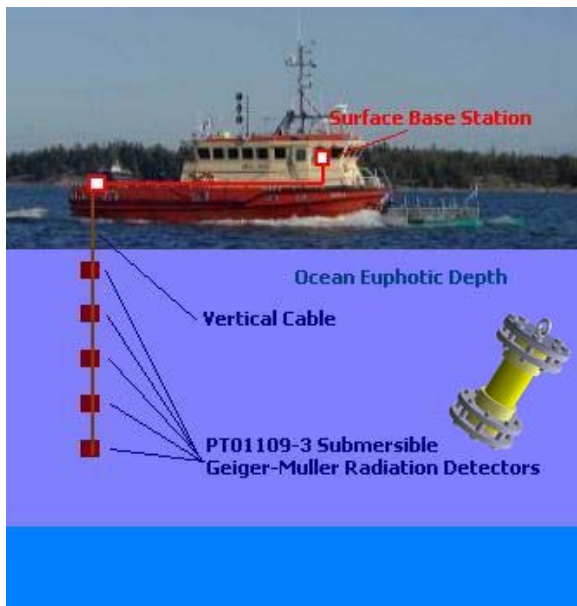

PT01109-3 Submersible Geiger-Muller Radiation Detector

PELCZAR TECHNOLOGY © 1987-2012 All rights reserved.

An Investor Wanted For This Project. More info at <http://www.pelczar.com.pl/investor.html>

info@pelczar.com.pl

The predominating ways of TENORM contamination

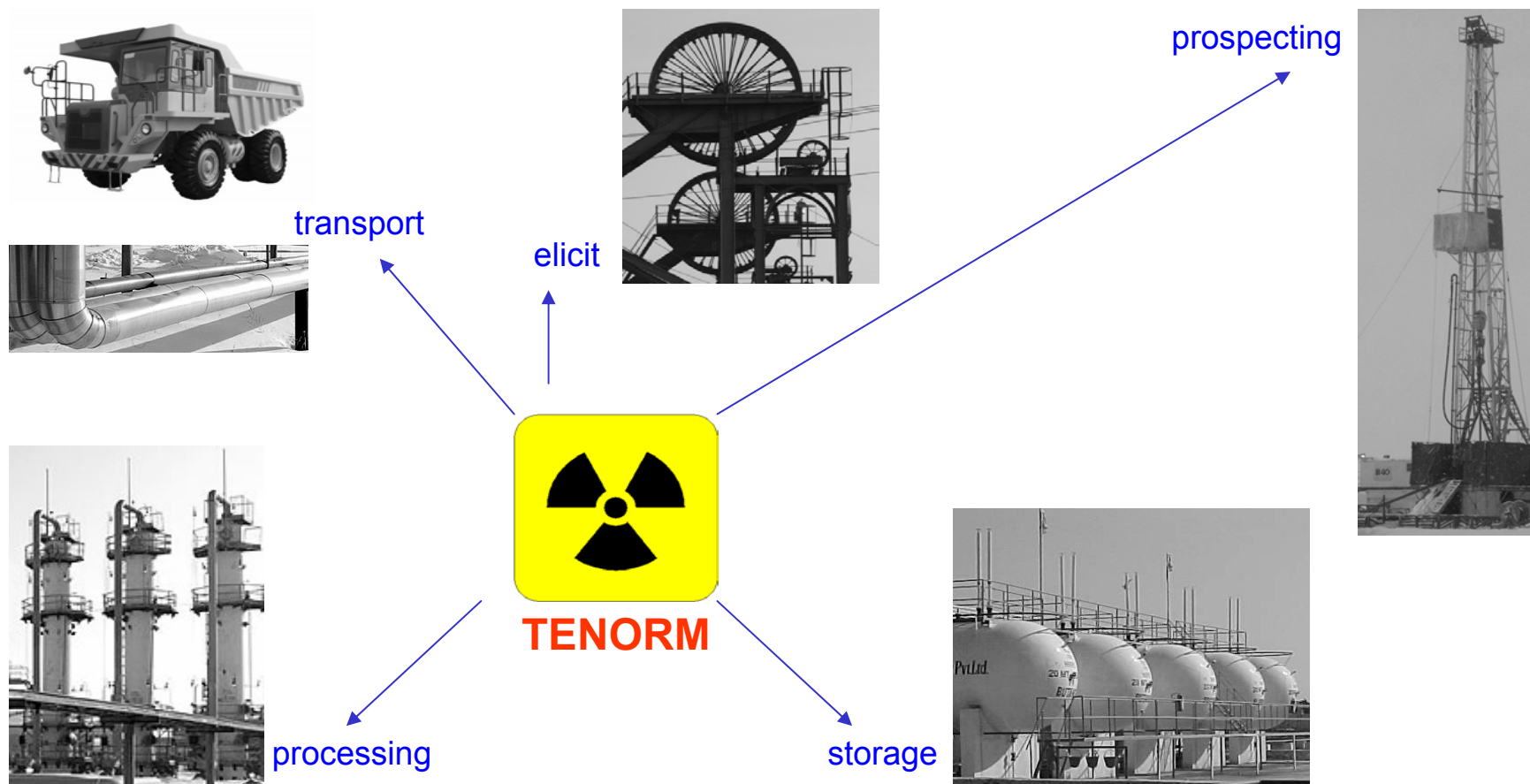

ALARA Project -an initiative for fighting the hazardous effects of Technologically Enhanced Naturally Occurring Radioactive Materials (TENORM)

<http://www.alara-project.com>

ALARA PROJECT
PELCZAR TECHNOLOGY © 1987-2011
All rights reserved.

info@pelczar.com.pl

PT10109 GSM Wireless Geiger-Muller Radiation Detector

The **PT10109** is a wireless sensor, which integrates a GSM/GPRS modems and a Geiger-Muller detector. It has been designed for surveying petroleum, natural gas, and LPG production facilities for Naturally Occurring Radioactive Materials (NORM) and artificially produced radionuclides.

The instrument is sensitive to gamma radiation with energy levels from 50keV to 1.25MeV with an effective dose rate measurement range between 0.01-200 μ Sv/h. The **PT10109** is designed to operate within harsh industrial environments as well as hazardous areas ATEX ZONE-0.

It can be permanently attached to field infrastructure and operated from an internal battery without the need for costly cabling and conduit runs, thus eliminating most of the permit and labour costs for layout planning and installation. The typical mode of operation is that the **PT10109** automatically performs a few readings of effective dose radiation per day and after each reading transmits the measurement data to a remote PLC/RTU by GSM/GPRS infrastructure.

Features:

- o Device to be permanently attached to field infrastructure
- o GSM/GPRS wireless interface for remote reading of radiation
- o Design for 3 years maintenance free operation
- o Quad-band GSM/GPRS modem
- o The sensor is energy-compensated Geiger-Muller tubes, sensitive with an energy level from 50keV to 1.25MeV; gamma sensitivity: 22 cps/mR/h (Co^{60}); working range: 0.014 -144 mR/h; effective capacity of detecting chamber 12.90 mm³
- o Sensitive to gamma radiation with an energy level from 50keV to 1.25MeV
- o Range of gamma radiation effective dose rate 0.01-200 μ Sv/h
- o Operating temperature range -40°C to 85°C
- o Powered from internal battery
- o Construction of device enclosures under EN 60079-18 (encapsulation 'ma'), ingress protection IP68
- o IrDA port for configuration download
- o Remote self-diagnostic function

Applications:

- o Survey of petroleum, natural gas, and LPG production facilities to measure radiation levels from NORM and artificially produced radionuclides

PT10109 GSM Geiger-Muller Sensor



**MADE IN
POLAND**

Designed to meet EC Declaration of Conformity requirements:

- o EN 301 511 Radio spectrum matters
- o EN 61000-6-2 Immunity standard for industrial environments
- o EN 61000-6-4 Emission standard for industrial environments
- o EN 60079-0 Electrical apparatus for explosive gas atmospheres. General requirements
- o EN 60079-18 Electrical apparatus for explosive gas atmospheres - Part 18: Construction, test and marking of type of protection encapsulation "m" electrical apparatus

BLOCK DIAGRAM of PT10109 GSM Wireless Geiger-Muller Detector

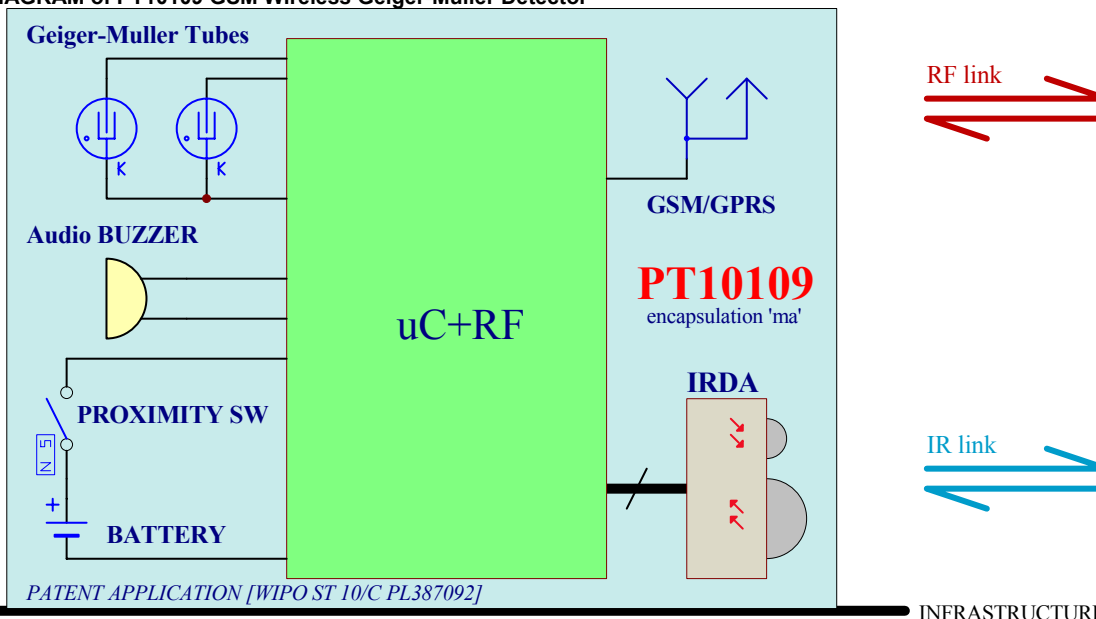

PT00109-1 ISM Wireless Geiger-Muller Radiation Detector

The **PT00109-1** is a wireless sensor, which integrates an ISM radio and a Geiger-Muller detector. It has been designed for surveying petroleum, natural gas, and LPG production facilities as well as drinking water and food articles production facilities for Naturally Occurring Radioactive Materials (NORM) and artificially produced radionuclides.

The instrument is sensitive to gamma radiation with energy levels from 50keV to 1.25MeV. The high sensitivity of the detectors allows their use in indirect detection of radon gas in air. The **PT00109-1** is designed to operate within harsh industrial environments as well as hazardous areas ATEX ZONE-1.

It can be permanently attached to field infrastructure and operated from an internal battery without the need for costly cabling and conduit runs, thus eliminating most of the permit and labour costs for layout planning and installation. The typical mode of operation is that the **PT00109-1** automatically performs a few readings of radiation emission in counts per second per sample volume [cps/l] per day and after each reading transmits the measurement data to a remote PLC/RTU by ISM radio.

Features:

- o Device to be permanently attached to field infrastructure
- o ISM wireless interface for remote reading of radiation
- o Design for 3 years maintenance free operation
- o The sensor is energy-compensated Geiger-Muller tubes, sensitive with an energy level from 50keV to 1.25MeV; gamma sensitivity: 22 cps/mR/h (Co^{60}); capacity of single GM detecting chamber 12.90 mm³
- o Higher counting efficiencies achieved by reversed Marinelli beaker geometry of the test chamber
- o Background compensated measurement of low level gamma and beta radiation emission in counts per second per sample volume [cps/l]
- o Estimation of NORM energy distribution by "Half-Value Layer" method
- o Operating temperature range -40°C to 85°C
- o Uses bi-directional a ISM radio operating in the license free 869MHz RF band
- o Operating range:
 - o 1km radio link range in open space
 - o 100m unidirectional radio link range in an industrial environment
 - o Up to 4km radio link range with a directional antenna
- o Powered from internal battery
- o Construction of device enclosures under EN 60079-18 (encapsulation 'ma'), ingress protection IP68
- o IrDA port for configuration download
- o Remote self-diagnostic function
- o Expandable point-to-multipoint network

- o EN 60079-18 Electrical apparatus for explosive gas atmospheres - Part 18: Construction, test and marking of type of protection encapsulation "m" electrical apparatus

PT00109-1 Geiger-Muller Sensor

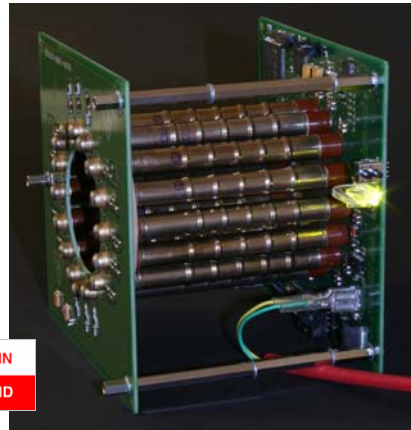

MADE IN
POLAND

Designed to meet EC Declaration of Conformity requirements:

- o EN 300 220 EMC and radio spectrum matters
- o EN 61000-6-2 Immunity standard for industrial environments
- o EN 61000-6-4 Emission standard for industrial environments
- o EN 60079-0 Electrical apparatus for explosive gas atmospheres. General requirements

Applications:

- o Survey of **petroleum, natural gas, and LPG** production facilities to measure radiation levels from TENORM
- o Survey of **drinking water and food** articles production facilities to measure radiation levels from NORM and artificially produced radionuclides
- o **Survey of rain and/or snow precipitations** to measure radiation levels from TENORM and artificially produced radionuclides
- o Can be configured as a **desktop instrument** and use to measure gamma and beta activities of **liquid and bulk materials** (food) on low contamination level usually masked by background radiation.

BLOCK DIAGRAM of PT00109 ISM Wireless Geiger-Muller Detector

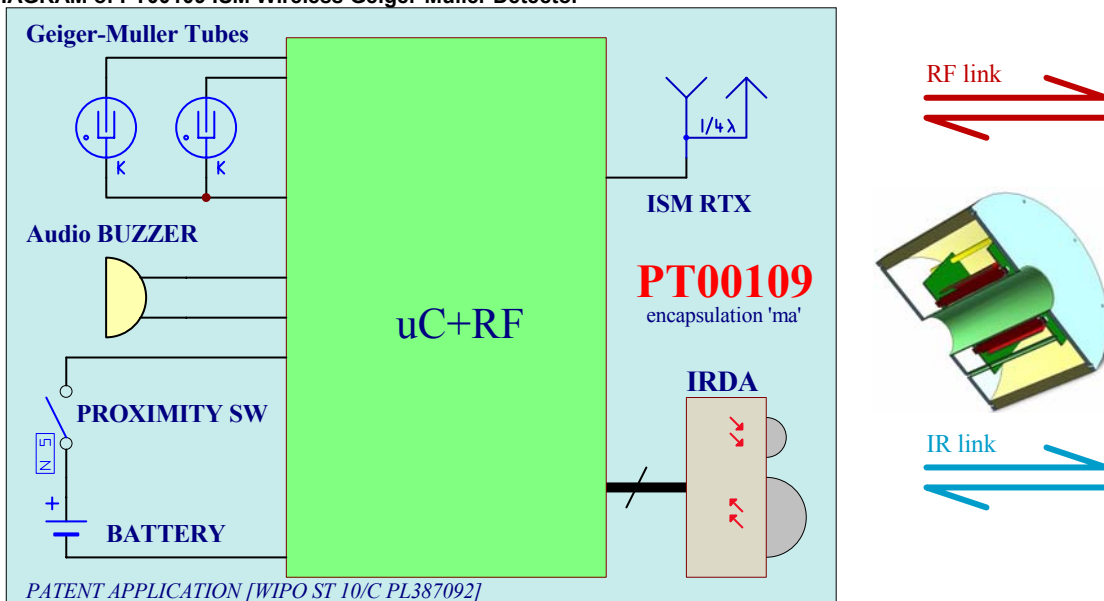

PT01109-1 Geiger-Muller Radiation Indicator to survey everyday nutrition, hygiene and personal goods for radionuclides contamination.

The instrument is dedicated to individuals and businesses to which the quality of everyday goods defines the living standard. The instrument target markets are purchasing and QC departments of supermarkets, restaurants, hotels, and hospitals, as well as private individuals.

The PT01109-1 is a computerized Geiger-Muller indicator. It has been designed for surveying of drinking water and food articles as well as hygiene products, household chemistry, cosmetics and building materials for Naturally Occurring Radioactive Materials (NORM) and artificially produced radionuclides.

Overall instrument compares radioactive activities between samples which have same, normalized volume.

The instrument is sensitive to **beta and gamma** radiation with wide range energy levels from 30keV to 1.2MeV. The wide range of detected energy levels makes the instrument useful for detecting the decay products from most NORM and artificial radioactive decay. The high sensitivity of the indicators allows their use in indirect detection of radon in air.

The result of the radioactive emission test is delivered in counts of captured gamma photons and beta particles per second and per 100ml of sample volume [cps/100ml]. The interpretation of the measurement results is a simple task performed by comparing the reading from tested samples to the reference specimen. The instrument operator has a choice of selecting his own reference or use the one included in the PT01109-1 set. To insure the repeatability of testing parameters, the specimen is tested after being placed in a 100ml normalized geometry test container.

The PT01109-1 is a desktop instrument fitted to the PE-HD, IK06 and IP67 enclosure, which can be immersed in running water and be washed.

The data output of radioactive emission of the tested specimen is in counts per integration time per 100ml of sample volume [cpt/100ml], and after each reading the measurement data is send to a remote PLC/RTU via an RS232 interface. The integration time period is software controlled.

The test result delivered by the PT01109-1 Geiger-Muller Indicator is for guidance only and requires verification using more elaborate equipments. In case of suspecting the radiological contamination the operator should contact his local authority responsible for radiological safety.

Features:

- The detector matrix is surrounds the test chamber (reversed Marinelli beaker geometry) and contains sixteen energy-compensated Geiger-Muller tubes, where each tube has its own dedicated readout interface and counter
- Geiger-Muller tubes are sensitive to gamma radiation with an energy level from 30keV to 1.2MeV; the gamma sensitivity is 22 cps/mR/h (Co⁶⁰); the volume of a single GM tube 12.90 mm³
- The test specimen is placed in a 100ml container
- The test chamber is shielded by a Pb layer
- The integration time is software controlled
- Measurement of the low level gamma and beta radiation emission is in counts per integration time per 100ml of the sample volume [cpt/100ml]
- The indicator is capable of capturing gamma and beta particles from the same nuclear decay as a two separate events
- Operating temperature range -40°C to 85°C
- RS232 interface to host system (19200 bps 8-N-1)
- The instrument data output format is suitable to paste directly in OpenOffice Calc worksheet
- Powered from 12V 0.6A DC power source (12VDC/230VAC power adapter included)
- Enclosure made of PE-HD; protection IP67 and IK06
- Self-diagnostic function
- Expandable for Ethernet interface for remote reading of radiation

Designed to meet EC/ANSI Declaration of Conformity requirements:

- ANSI N42.35-2004 Evaluation and Performance Criteria of Radiation Detection Portal Monitor for Use in Homeland Security (excluding requirements 5.10 and 5.10.4.2)
- EN 61000-6-2 Immunity standard for industrial environments
- EN 61000-6-4 Emission standard for industrial environments

Applications:

- Surveys everyday nutrition, hygiene and personal goods for radionuclides contamination
- **Quickly and discreetly checks** the quality of delivered goods for radionuclides contamination
- Helps to identify the products that contains more radionuclides than others

PT01109-1 Geiger-Muller Radiation Indicator with 100ml test containers



- Single unit netto price (EXW Niepolomice Poland, B2B only) is **2800 EUR** per unit
- The Manufacturing Pack is available for qualified customers (B2B only)

PT01109-1 Geiger-Muller Radiation Detector to survey everyday nutrition, hygiene and personal goods for radionuclides contamination.

<http://www.pelczar.com.pl/PT01109-Desktop-Geiger-Muller-Radiation-Indicator.pdf>

PELCZAR TECHNOLOGY © 1987-2011
All rights reserved.

info@pelczar.com.pl